

Menfis

by Mario Ruiz

2025-26

made design

Menfis

by Mario Ruiz

This range of minimalist signage makes the message relevant; it's almost invisible form is perfect for all types of public or private buildings. For wall, desktop, free standing, hanging and projected it's a modular system with custom size, allows you to adapt to all your needs.

Esta gama de señalética minimalista hace relevante el mensaje, su forma casi invisible es perfecta para todo tipo de edificios públicos o privados. Para pared, sobremesa, de pie, colgante y proyectado y un sistema modular con tamaño personalizado, le permite adaptarse a todas las necesidades.

Cette gamme de signalétique minimaliste rend le message pertinent, sa forme presque invisible est parfaite pour tous les types de bâtiments publics ou privés. Sur le mur, le bureau, debout, suspendu et projeté, il s'agit d'un système modulaire à la taille personnalisée, il permet de s'adapter à tous les besoins.

Questa gamma di segnaletica il minimalista rende rilevante il messaggio, la sua forma quasi invisibile è perfetto per tutti i tipi di edifici pubblici o privati. Da parete, da tavolo, da appoggio, sospeso e proiettato e un sistema modulare con un formato personalizzato, gli permette di adattarsi a tutte le necessità.



FLOOR 3
A4

WORK AREA

7
GROUP

Mr. Menfis



Studio 2



Silence



Wait



Meeting Room



ing area

- made4u
- floor 5 Terrace
- floor 4 Dining area
- floor 3 I+D
- floor 2 Design room
- floor 1 Convention hall
- floor 0 Main entrance made4u



More about Memphis

DESIGNER

Mario Ruiz

YEAR

2010

LINE SKETCH

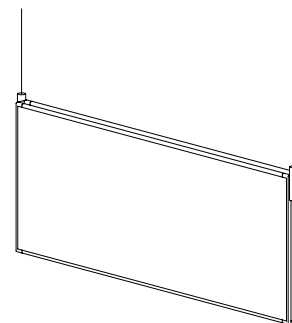

SCALE 1:10 (cm)

PRODUCT

REFERENCE

SIZE

WALL MOUNT

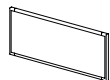

MEN 01

MEN 02

MEN 03

MEN 04

	x	5	7	10,5	21	29,7	32	48	64	72	96	cm
	x	2	2,7	4,1	8,3	11,7	12,6	18,9	25,2	28,3	37,8	in.
MEN 01	5,25 2,1		•	•	•	•	•	•	•	•	•	
MEN 02	7 2,7		•	•	•	•	•	•	•	•	•	
MEN 03	10,5 4,1			•	•	•	•	•	•	•	•	
MEN 04	21 8,3				•	•	•	•	•	•	•	



HANGING SUPPORT – MEN 21

PRODUCT	REFERENCE	SIZE											
PROJECTED 		x	5	7	10,5	21	29,7	32	48	64	72	96	cm
		x	2	2,7	4,1	8,3	11,7	12,6	18,9	25,2	28,3	37,8	in.
	MEN 11		10,5			•	•						
	MEN 12		21			•	•						

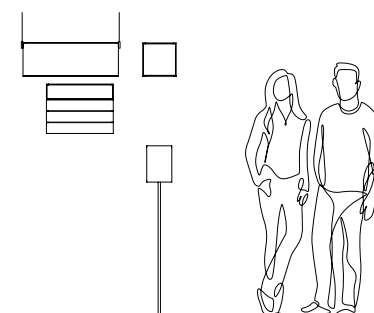

COMPOSITION WITH WALL SUPPORT — MEN 01 + MEN 03

More about Memphis

DESIGNER

Mario Ruiz

YEAR

2010

LINE SKETCH

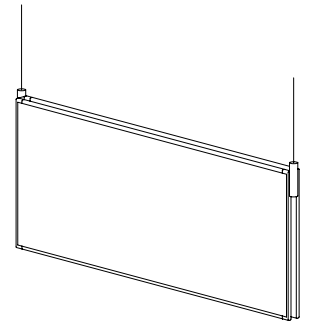

SCALE 1:10 (cm)

PRODUCT

REFERENCE

SIZE

HANG

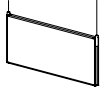

MEN 21

x	5	7	10,5	21	29,7	32	48	64	72	96	cm
x	2	2,7	4,1	8,3	11,7	12,6	18,9	25,2	28,3	37,8	in.
							•	•	•	•	

DESK



MEN 31

MEN 32

MEN 33

MEN 34

x	5	7	10,5	21	29,7	32	48	64	72	96	cm
x	2	2,7	4,1	8,3	11,7	12,6	18,9	25,2	28,3	37,8	in.
	5,25		•	•							
	2,1										
	7		•	•							
	2,7										
	10,5		•	•							
	4,1										
	21			•	•						
	8,3										



DESKTOP SUPPORT — MEN 31

PRODUCT	REFERENCE	SIZE											
STAND 		x	5	7	10,5	21	29,7	32	48	64	72	96	cm
		x	2	2,7	4,1	8,3	11,7	12,6	18,9	25,2	28,3	37,8	in.
	MEN 41		21				•	•					
			8,3										

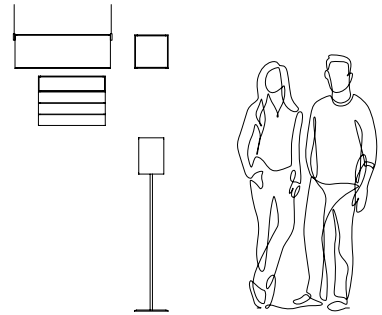

STANDING SUPPORT DETAIL – MEN 41

Menfis

by Mario Ruiz

CHARACTERISTICS

Signage system made using white lacquered extruded aluminium. The side caps are injected into zamak. Available in 4 height sizes and variable width as required. Covered using transparent plastic sheets that protect the signage. Suction cup is supplied for document extraction. Wall fixing using rawlplugs and screws or double-sided adhesive.

CARACTERÍSTICAS







Sistema de señalización fabricado en aluminio extrusionado y lacado en blanco. Las tapas laterales están inyectadas en zamak. Disponible en 4 tamaños de altura y de anchura variable según necesidad. Lámina plástica transparente que protege el papel con la indicación. Se suministra ventosa para extracción del documento. Fijación a pared mediante taco y tornillo o adhesivo doble cara.

CARACTÉRISTIQUES

Système de signalétique en aluminium extrudé et laqué blanc. Les parties latérales sont injectées en zamak. Disponible en 4 hauteur différentes et de largeur variable selon les besoins. Feuille de plastique transparente qui protège le papier avec l'indication. Une ventouse est fournie pour l'extraction des documents. Fixation au mur à l'aide de cheville et vis ou d'un adhésif double face.

CARATTERISTICHE

Sistema di segnalazione realizzato in alluminio estruso e laccato bianco. Le coperture laterali sono iniettate in zamak. Disponibile in 4 misure di altezza e larghezza variabile a seconda delle necessità. Pellicola di plastica trasparente che protegge la carta con l'indicazione. Viene fornita una ventosa per l'estrazione dei documenti. Fissaggio a parete con tassello e vite o biadesivo.

	REF	↕↔			REF	↕↔		
 WALL	MEN 01 21	21 x 21 cm	0,4 kg / 0,9 lb.	 HANGED	MEN 04 07	7 x 5,25 cm	0,1 kg / 0,2 lb.	
	MEN 01 29	29,7 x 21 cm	0,6 kg / 1,3 lb.		MEN 04 10	10,5 x 5,25 cm	0,1 kg / 0,2 lb.	
	MEN 01 32	32 x 21 cm	0,6 kg / 1,3 lb.		MEN 04 21	21 x 5,25 cm	0,1 kg / 0,2 lb.	
	MEN 01 48	48 x 21 cm	0,9 kg / 2 lb.		MEN 04 32	32 x 5,25 cm	0,2 kg / 0,4 lb.	
	MEN 01 64	64 x 21 cm	1,2 kg / 2,6 lb.		MEN 04 48	48 x 5,25 cm	0,2 kg / 0,4 lb.	
	MEN 01 72	72 x 21 cm	1,3 kg / 2,9 lb.		MEN 04 64	64 x 5,25 cm	0,3 kg / 0,7 lb.	
	MEN 01 96	96 x 21 cm	1,7 kg / 3,7 lb.		MEN 04 72	72 x 5,25 cm	0,3 kg / 0,7 lb.	
	MEN 02 10	10,5 x 10,5 cm	0,1 kg / 0,2 lb.		MEN 04 96	96 x 5,25 cm	0,4 kg / 0,9 lb.	
	MEN 02 21	21 x 10,5 cm	0,2 kg / 0,4 lb.		 DESK	MEN 21 48	48 x 21 cm	1,8 kg / 4 lb.
	MEN 02 32	32 x 10,5 cm	0,3 kg / 0,7 lb.			MEN 21 64	64 x 21 cm	2,4 kg / 5,3 lb.
	MEN 02 48	48 x 10,5 cm	0,4 kg / 0,9 lb.			MEN 21 72	72 x 21 cm	2,6 kg / 5,7 lb.
	MEN 02 64	64 x 10,5 cm	0,5 kg / 1,1 lb.			MEN 21 96	96 x 21 cm	3,4 kg / 7,5 lb.
	MEN 02 72	72 x 10,5 cm	0,6 kg / 1,3 lb.			 STAND	MEN 31 21	21 x 21 cm
	MEN 02 96	96 x 10,5 cm	0,7 kg / 1,5 lb.		MEN 31 29		29,7 x 21 cm	0,7 kg / 1,5 lb.
	MEN 03 07	7 x 7 cm	0,1 kg / 0,2 lb.		MEN 32 10		10,5 x 10,5 cm	0,2 kg / 0,4 lb.
MEN 03 10	10,5 x 7 cm	0,1 kg / 0,2 lb.	MEN 32 21	21 x 10,5 cm	0,3 kg / 0,7 lb.			
MEN 03 21	21 x 7 cm	0,2 kg / 0,4 lb.	MEN 33 10	10,5 x 7 cm	0,1 kg / 0,2 lb.			
MEN 03 32	32 x 7 cm	0,3 kg / 0,7 lb.	MEN 33 21	21 x 7 cm	0,7 kg / 1,5 lb.			
MEN 03 48	48 x 7 cm	0,4 kg / 0,9 lb.	MEN 34 10	10,5 x 5,25 cm	0,1 kg / 0,2 lb.			
MEN 03 64	64 x 7 cm	0,5 kg / 1,1 lb.	MEN 34 21	21 x 5,25 cm	0,2 kg / 0,4 lb.			
MEN 03 72	72 x 7 cm	0,6 kg / 1,3 lb.	MEN 41 21	21 x 21 cm	8 kg / 17,6 lb.			
MEN 03 96	96 x 7 cm	0,7 kg / 1,5 lb.	MEN 41 29	21 x 29,7 cm	8,2 kg / 18,1 lb.			
 PROJECTED	MEN 11 21	21 x 21 cm	1,3 kg / 2,9 lb.					
	MEN 11 29	29,7 x 21 cm	1,6 kg / 3,5 lb.					
	MEN 12 21	21 x 10,5 cm	0,2 kg / 0,4 lb.					
	MEN 12 29	29,7 x 10,5 cm	0,3 kg / 0,7 lb.					

ENVIRONMENTAL IMPACT

Materials may be easily disassembled to be recycled.

Materiales fácilmente segregables para su posterior reciclado.

Matériaux facilement démontables pour leurs recyclages.

Materiali facilmente separabile per un successivo riciclaggio.

FIRE RESISTANCE

RESISTENCIA AL FUEGO

RÉSISTANCE AU FEU

RESISTENZA AL FUOCO

UNE-EN 13501-1

A1-s1, d0

WARRANTY

Two (2) year limited warranty. Does not cover: incorrect use, bad handling or deliberate damage.

GARANTIA

Garantía de dos (2) años limitada. No cubre: mal uso, manipulación o daños intencionados.

GARANTIE

Garantie deux (2) ans. À l'exception: mauvaise utilisation, manipulation, dommages intentionnés.

GARANZIA

Due (2) anni di garanzia limitati. Non copre: uso improprio, manipolazione o danno intenzionale.

PACKAGING

Cardboard box with plastic bag for product protection. One package.

EMBALAJE

Caja de cartón con bolsa de plástico para protección. Un paquete.

EMBALLAGE







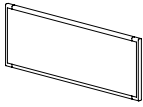









Boîte en carton avec sac plastique pour la protection. Un paquet.

IMBALLAGGIO

Scatola di cartone con sacchetto di plastica per protezione. Un pacco.



BRAND COLORS

 BL · Ral 9003	 VD · Ral 6000
 CE · Ral 7033	 PE · Ral 5020
 GR · Ral 7015	 AZ · Ral 5009
 AN · Ral 7016	 BD · Ral 3005
 MA · Ral 8014	 RJ · Ral 3020
 OP · Ral 1036	 RS · Ral 2012
 VF · Ral 6020	 AM · Ral 1007
 VO · Ral 6011	 NJ · Ral 2017

CUSTOMIZE OPTIONS

OPCIONES PERSONALIZADAS









PERSONNALISER LES OPTIONS

OPZIONI DI PERSONALIZZAZIONE

 RAL COLOR



LABELS

Thickness		1,5 mm	Acoustic		Doesn't absorb sound
Material		Aluminium	Fire resistance		UNE-EN 13501-1 A1-s1, d0
Finish		Lacquered	Optimal Space		Indoor
Conductivity		100%	Cleaning		Water & Drying
			Weight		See page 308

Headquarters

Polígono Industrial Pla d'en Coll
Camí de la Font Freda 17, Nave 4
08110 Montcada i Reixac
Barcelona, Spain

www.madedesign.es

follow us
[@made_design](https://twitter.com/made_design)

is part of
 Planning Sisplamo



ER-0209/2021



GA-2021/0082