

Go

by Gemma Bernal

2025-26

made design

Go

by Gemma Bernal

GO is a mobile multifunctional metal furniture for offices and meeting spaces. Wardrobes, shelves, recycling bins, coat racks, acoustic panels and whiteboards can be combined with its extensive range of accessories. Also available in 16 colors from our RAL chart. Configurable system equipped with wheels with brakes.

GO es un mueble metálico multifuncional móvil para oficinas y espacios de reuniones. Armarios, estanterías, papeleras de reciclaje, percheros, paneles acústicos y pizarras son combinables con su extensa gama de accesorios. Además disponible en 16 colores de nuestra carta RAL. Sistema configurable dotado de ruedas con freno.

GO est un mobilier métallique multifonctionnel mobile pour bureaux et espaces de réunion. Armoires, étagères, poubelles de recyclage, porte-manteaux, panneaux acoustiques et tableaux blancs peuvent être combinés grâce à sa vaste gamme d'accessoires. Également disponible en 16 couleurs de notre nuancier RAL. Système configurable équipé de roues avec freins.

GO è un mobile metallico multifunzionale per uffici e spazi meeting. Armadi, scaffali, contenitori per la raccolta differenziata, appendiabiti, pannelli acustici e lavagne possono essere combinati con la sua vasta gamma di accessori. Disponibile anche in 16 colori dalla nostra tabella RAL. Sistema configurabile dotato di ruote con freno.











Thanks to its versatility, the GO configurable modular system allows you to design meeting and training areas based on the number of participants on each occasion.

Grâce à sa polyvalence, le système modulaire configurable GO vous permet de concevoir des espaces de réunion et de formation en fonction du nombre de participants à chaque occasion.

Gracias a su versatilidad, el sistema modular configurable GO, permite diseñar áreas de reuniones y de formación en función al número de participantes en cada ocasión.

Grazie alla sua versatilità, il sistema modulare configurabile GO consente di progettare aree di incontro e formazione in base al numero di partecipanti in ogni occasione.



More about GO

DESIGNER

Gemma Bernal





YEAR

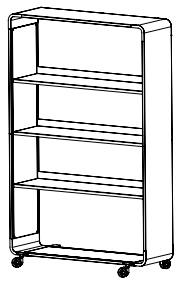



2024

LINE SKETCH



SCALE 1:20 (cm)

PRODUCT	REFERENCE	SIZE
	GOO 10 Structure & wheels	180 x 115 x 35 cm 70,9 x 45,3 x 13,8 in.
	GOO 101 Shelf	31 x 110 cm 12,2 x 43,3 in.
	GOO 102 Shelf + hanging bar	31 x 110 cm - Ø 2 cm 12,2 x 43,3 in. - Ø 0,8 in.
	GOO 103 Lacquered whiteboard	170 x 110 cm 66,9 x 43,3 in.
	GOO 104 Enamel whiteboard	170 x 110 cm 66,9 x 43,3 in.

PRODUCT	REFERENCE	SIZE
	GOO 113 Lacquered whiteboard	85 x 110 cm 33,5 x 43,3 in.
	GOO 114 Enamel whiteboard	85 x 110 cm 33,5 x 43,3 in.
	GOO 105 Pet panel	170 x 110 cm 66,9 x 43,3 in.
	GOO 115 Pet panel	85 x 110 cm 33,5 x 43,3 in.
	GOO 107 TV support	39,4 x 16 cm 15,5 x 6,3 in.



MAGNETIC TRAY / ACCESSORIES





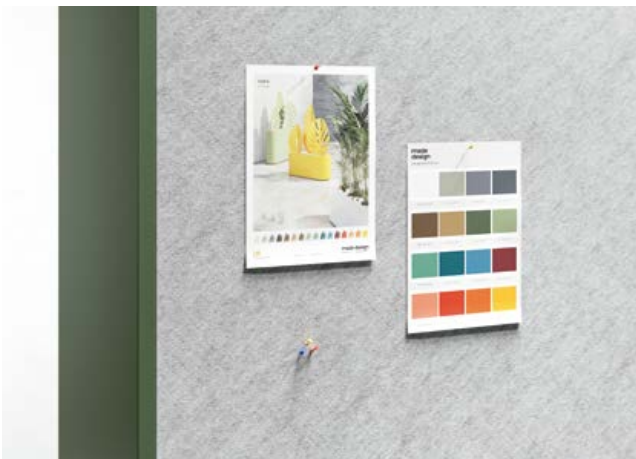
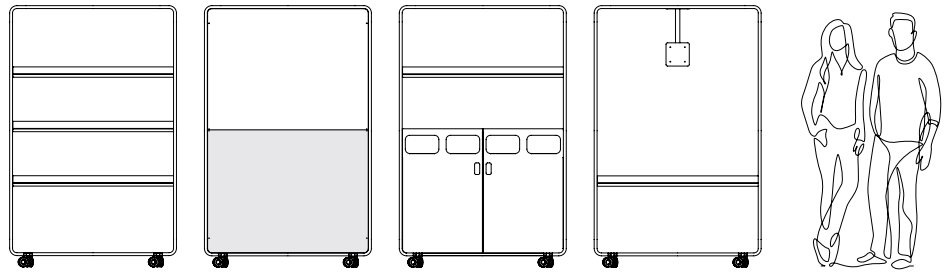





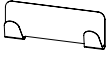
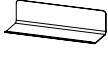

MAGNETIC WASTEPAPER / ACCESSORIES

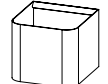
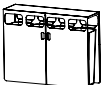

WHITEBOARD / PET ACOUSTIC PANEL

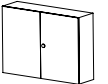
MAGNETIC HANGER

PRODUCT	REFERENCE	SIZE	PRODUCT	REFERENCE	SIZE
	GOO 108 Magnetic hanger	10 x 30 cm - ∠ 25° 3,9 x 11,8 in.		SAG 80 Marker pen tray	20 x 5,5 x 6,7 cm 68,9 x 35 x 19,7 in.
	GOO 109 Magnetic wastepaper	25 x 17 x 17 cm 9,8 x 6,7 x 6,7 cm		SAG 81 Magnetic eraser	15,5 x 7 x 4,7 cm 7,9 x 2,2 x 2,6 cm
	GOO 110 Magnetic tray	10 x 30 x 10 cm 3,9 x 11,8 x 3,9 in.		SAG 82 Vertical marker holder	14 x 5,5 x 3,5 cm 6,1 x 2,7 x 1,8 in.
	GOO 120 Recycling kit	65 x 110 x 31 cm 25,6 x 43,3 x 12,2 in.		SAG 83 Container Cup	11,5 x 9,3 x 11 cm 4,5 x 3,7 x 4,3 in.
	GOO 130 Recycling cabinet	85 x 110 x 30 cm 33,5 x 43,3 x 11,8 in.		9003 Pack of 6 white magnets	∅ 25 mm
	GOO 140 Cabinet	80 x 110 x 30 cm 31,5 x 43,3 x 11,8 in.		7005 Pack of 4 Markers	



ROUND CORNER & SHELF



LEVELERS & CASTORS



RECYCLING KIT



RECYCLING CABINET



HANGER / CABINET





















TV SUPPORT / SHELF



GO

by Gemma Bernal

CHARACTERISTICS	CARACTERÍSTICAS	CARACTÉRISTIQUES	CARATTERISTICHE
Modular furniture made of 1.2 mm sheet metal. Its structure is welded and polished forming a perfect ring. The metal feet made of 4 mm handrails. Equipped with wheels with brakes (2 front) The accessories and components are fixed to the body using screws. External accessories by magnet.	Mueble modular fabricado en chapa metálica de 1,2 mm. Su estructura está soldada y pulida formando un aro perfecto. Los pies metálicos fabricados en pasamanos de 4 mm. Dotados de ruedas con freno (2 delanteras) Los accesorios y componentes se fijan al cuerpo mediante tornillería. Los complementos exteriores mediante imán.	Mobilier modulaire en tôle de 1,2 mm. Sa structure est soudée et polie formant un anneau parfait. Les pieds métalliques constitués de mains courantes de 4 mm. Equipé de roues avec freins (2 à l'avant) Les accessoires et composants sont fixés à la carrosserie à l'aide de vis. Accessoires externes par aimant.	Mobili componibili realizzati in lamiera da 1,2 mm. La sua struttura è saldata e lucidata formando un anello perfetto. I piedini in metallo sono costituiti da corrimano da 4 mm. Dotato di ruote con freno (2 anteriori). Gli accessori e componenti sono fissati alla scocca tramite viti. Accessori esterni tramite calamita.

REF	↕↔		REF	↕↔			
	GOO 10	180 x 115 x 35 cm 70,9 x 45,3 x 13,8 in.	48,9 kg 107,8 lb.		GOO 107	39,4 x 16 cm 15,5 x 6,3 in.	0,8 kg 1,8 lb.
	GOO 101	31 x 110 cm 12,2 x 43,3 in.	3,7 kg 8,1 lb.		GOO 108	10 x 30 cm - ∠ 25° 3,9 x 11,8 in.	0,3 kg 0,7 lb.
	GOO 102	31 x 110 cm - Ø 2 cm 12,2 x 43,3 in. - Ø 0,8 in.	4,6 kg 10,1 lb.		GOO 109	25 x 17 x 17 cm 9,8 x 6,7 x 6,7 cm	1,7 kg 3,7 lb.
	GOO 103	110 x 170 cm 43,3 x 66,9 in.	12 kg 26,4 lb.		GOO 110	10 x 30 x 10 cm 3,9 x 11,8 x 3,9 in.	0,9 kg 1,9 lb.
	GOO 104	170 x 110 cm 66,9 x 43,3 in.	31 kg 68,3 lb.		GOO 120	65 x 110 x 31 cm 25,6 x 43,3 x 12,2 in.	22,6 kg 49,8 lb.
	GOO 113	85 x 110 cm 33,5 x 43,3 in.	7 kg 15,4 lb.		GOO 130	85 x 110 x 30 cm 33,5 x 43,3 x 11,8 in.	18,7 kg 41,2 lb.
	GOO 114	85 x 110 cm 33,5 x 43,3 in.	17 kg 37,5 lb.		GOO 140	80 x 110 x 30 cm 31,5 x 43,3 x 11,8 in.	24,7 kg 54,4 lb.
	GOO 105	170 x 110 cm 66,9 x 43,3 in.	3,6 kg 7,9 lb.				
	GOO 115	85 x 110 cm 33,5 x 43,3 in.	1,8 kg 3,9 lb.				

ENVIRONMENTAL IMPACT				FIRE RESISTANCE	RÉSISTANCE AU FEU
				RESISTENCIA AL FUEGO	RESISTENZA AL FUOCO
Materials may be easily disassembled to be recycled.	Materiales fácilmente segregables para su posterior reciclado.	Matériaux facilement démontables pour leurs recyclages.	Materiali facilmente separabile per un successivo riciclaggio.	UNE-EN 13501-1	A1-s1, d0

WARRANTY	GARANTIA	GARANTIE	GARANZIA	PACKAGING	EMBALAJE	EMBALLAGE	IMBALLAGGIO
Two (2) year limited warranty. Does not cover: incorrect use, bad handling or deliberate damage.	Garantía de dos (2) años limitada. No cubre: mal uso, manipulación o daños intencionados.	Garantie deux (2) ans. À l'exception: mauvaise utilisation, manipulation, dommages intentionnés.	Due (2) anni di garanzie limitati. Non copre: uso improprio, manipolazione o danno intenzionale.	Cardboard box with plastic bag for product protection. One package.	Caja de cartón con bolsa de plástico para protección. Un paquete.	Boîte en carton avec sac plastique pour la protection. Un paquet.	Scatola di cartone con sacchetto di plastica per protezione. Un pacco.



BRAND COLORS

-  BL · Ral 9003
-  CE · Ral 7033
-  GR · Ral 7015
-  AN · Ral 7016
-  MA · Ral 8014
-  OP · Ral 1036
-  VF · Ral 6020
-  VO · Ral 6011
-  VD · Ral 6000
-  PE · Ral 5020
-  AZ · Ral 5009
-  BD · Ral 3005
-  RJ · Ral 3020
-  RS · Ral 2012
-  AM · Ral 1007
-  NJ · Ral 2017

CUSTOMIZE OPTIONS

OPCIONES PERSONALIZADAS

PERSONNALISER LES OPTIONS

OPZIONI DI PERSONALIZZAZIONE

 RAL COLOR



BRAND COLORS

-  NI · Natural Iron

LABELS

Thickness  1,2 mm

Material  Iron

Finish  Painting

Conductivity  100%

Acoustic  Doesn't absorb sound

Fire resistance  UNE-EN 13501-1 A1-51,d0

Optimal Space  Indoor

Cleaning  Water & Drying

Weight  48,9 kg / 107,8 lb. unit



Headquarters

Polígono Industrial Pla d'en Coll
Camí de la Font Freda 17, Nave 4
08110 Montcada i Reixac
Barcelona, Spain

www.madedesign.es

follow us
[@made_design](https://twitter.com/made_design)

is part of
 Planning Sisplamo

